

Lecture #24

ANNOUNCEMENT

- Special session (led by the TA's):
 - MEDICI demonstration (for Part II of Design Project)
 - 3-4 PM, Friday April 18, 521 Cory (Hogan Room)

OUTLINE

The MOSFET (cont.)

- Theory of Operation
- Long-channel I - V (Square-Law Theory)

(Reading: Textbook Chapter 17.2)

Spring 2003

EE130 Lecture 24, Slide 1

Bias-Temperature Stress Measurement

Used to determine mobile charge density in MOS dielectric (units: C/cm²)

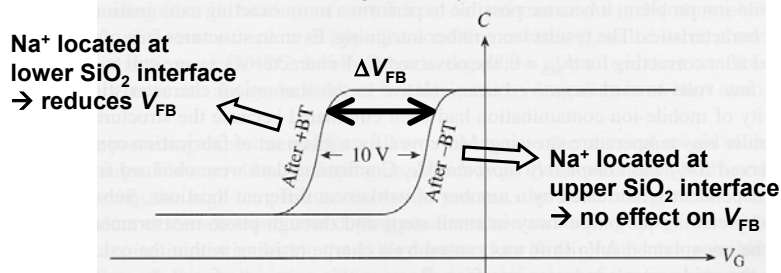

Positive oxide charge shifts the flatband voltage in the negative direction:

$$V_{FB} = \phi_{MS} - \frac{Q_F}{C_{ox}} - \frac{1}{\epsilon_{SiO_2}} \int_0^{t_{ox}} x \rho_{ox}(x) dx - \frac{Q_{IT}(\psi_s)}{C_{ox}}$$

$$Q_M = -C_{ox} \Delta V_{FB}$$

Spring 2003

EE130 Lecture 24, Slide 2

Clarification: Effect of Interface Traps

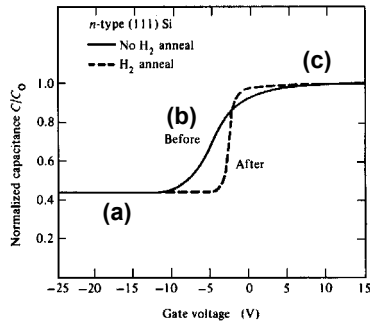

“Donor-like” traps are charge-neutral when filled, positively charged when empty

Positive oxide charge causes C-V curve to shift toward left (more shift as V_G decreases)

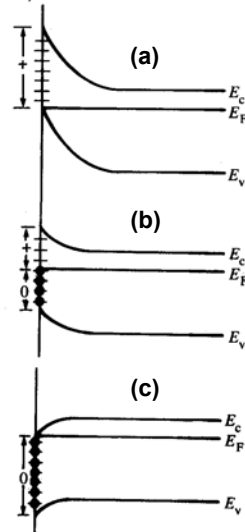

Traps cause “sloppy” C-V and also greatly degrade mobility in channel

$$\Delta V_G = -\frac{Q_{IT}(\psi_s)}{C_{ox}}$$

Spring 2003

EE130 Lecture 24, Slide 3

NMOSFET Operation (Qualitative)

$V_{GS} < V_T$:

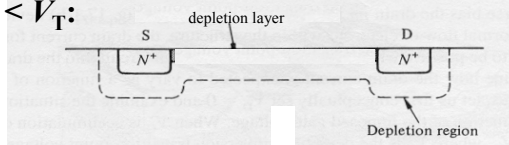

$V_{GS} > V_T$:

$V_{DS} \approx 0$

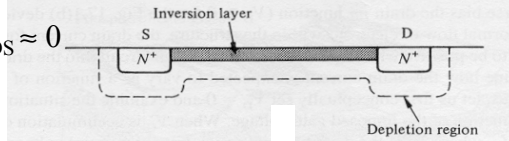

$$I_{DS} = WQ_{inv}v$$

$$= WQ_{inv}\mu_{eff}\mathcal{E}$$

$V_{DS} > 0$

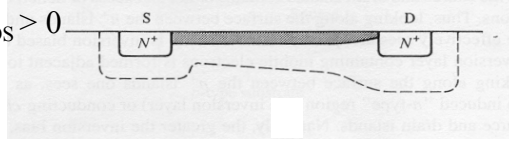

$$= WQ_{inv}\mu_{eff}\left(\frac{V_{DS}}{L}\right)$$

Spring 2003

EE130 Lecture 24, Slide 4

Pinch-Off & Channel-Length Modulation

$$V_{GS} > V_T:$$

$$V_{DS} = V_{GS} - V_T$$

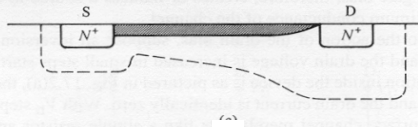

$$V_{DS} > V_{GS} - V_T$$

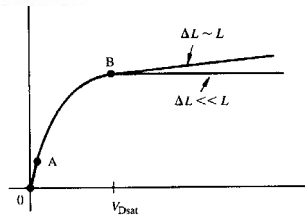
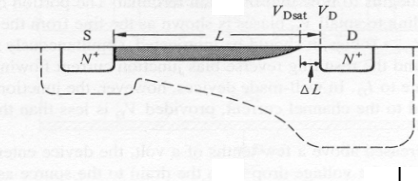

Spring 2003

EE130 Lecture 24, Slide 5

Ideal MOSFET I - V Characteristics

(Enhancement Mode Transistor)

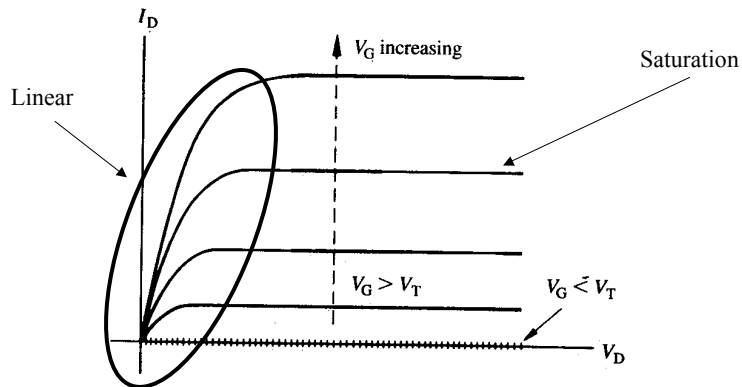

Spring 2003

EE130 Lecture 24, Slide 6

Effective Mobility

$$I_{DS} = WQ_{inv}v = WQ_{inv}\mu_{eff}\mathcal{E} = WQ_{inv}\mu_{eff}\left(\frac{V_{DS}}{L}\right)$$

$$= (W/L)\mu_{eff}C_{oxe}(V_G - V_T)V_{DS}$$

- Note that the MOSFET can be modelled as a resistor, for low V_{DS}

$$R_{DS} = \frac{V_{DS}}{I_{DS}} = \frac{L}{W\mu_{eff}C_{oxe}(V_G - V_T)}$$

- μ_{eff} is the **effective electron mobility**

Spring 2003

EE130 Lecture 24, Slide 7

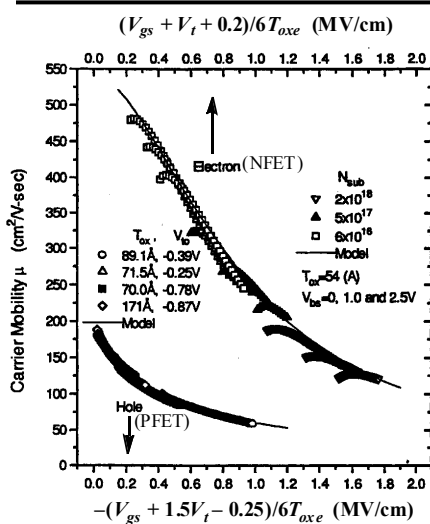

Scattering mechanisms:

- coulombic scattering
- phonon scattering
- surface roughness scattering

Empirically, we see:

$$\mu_{eff} = \frac{\mu_0}{1 + \theta(V_G - V_T)}$$

Spring 2003

EE130 Lecture 24, Slide 8

NMOSFET I - V Characteristics

- $V_D > V_S$
- Current in the channel flows by drift
- Channel voltage $V_C(y)$ varies continuously between the source and the drain

$$V_T = V_{FB} + V_C(y) + 2\psi_B + \frac{\sqrt{2qN_A\epsilon_{Si}(2\psi_B + V_{CB}(y))}}{C_{ox}}$$

- Channel inversion charge

$$Q_{inv}(y) = -C_{oxe} \left[V_G - V_{FB} - V_C(y) - 2\psi_B - \frac{Q_{dep}(y)}{C_{oxe}} \right]$$

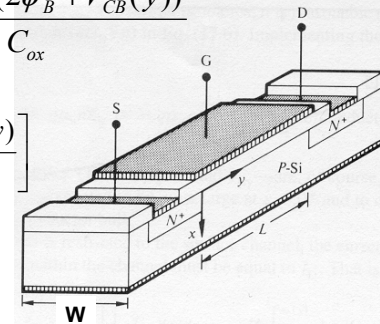

Spring 2003

EE130 Lecture 24, Slide 9

1st-Order Approximation

- Neglect variation of Q_{dep} with y

$$Q_{dep} = \sqrt{2qN_A\epsilon_{Si}(2\psi_B + V_{SB})}$$

$$\Rightarrow Q_{inv} = -C_{oxe} [V_G - V_T + V_S - V_C]$$

where V_T = threshold voltage at source end

Spring 2003

EE130 Lecture 24, Slide 10

NMOSFET Current (1st-order approx.)

- Consider an incremental length dy in the channel.
The voltage drop across this region is

$$dV_C = I_{DS} dR = I_{DS} \frac{dy}{\sigma W T_{inv}} = I_{DS} \frac{dy}{q \mu_{eff} n W T_{inv}} = - \frac{I_{DS} dy}{Q_{inv} \mu_{eff} W}$$

$$\int_0^L I_{DS} dy = - \int_{V_S}^{V_D} \mu_{eff} W Q_{inv}(V_C) dV_C$$

$$I_{DS} = - \frac{W}{L} \mu_{eff} \int_{V_S}^{V_D} Q_{inv}(V_C) dV_C$$

$$I_{DS} = \frac{W}{L} \mu_{eff} C_{oxe} \left[V_{GS} - V_T - \frac{V_{DS}}{2} \right] V_{DS}$$

Spring 2003

EE130 Lecture 24, Slide 11

Saturation Current

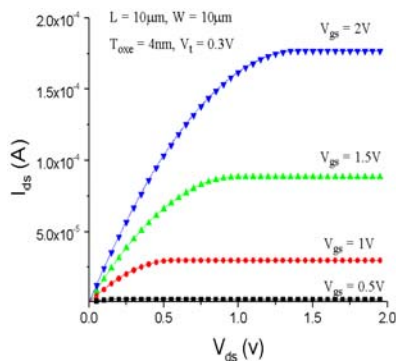

- saturation region:

$$V_D \geq V_{Dsat} = V_{GS} - V_T$$

$$I_{Dsat} = \frac{W}{2L} C_{oxe} \mu_{eff} (V_{GS} - V_T)^2$$

Spring 2003

EE130 Lecture 24, Slide 12