Experiment 2

Introduction to PSpice

W.T. Yeung and R.T. Howe

**UC Berkeley EE 105
Fall 2005**

1.0 Objective

One of the CAD tools you will be using as an circuit designer is SPICE, a Berkeley-developed industry-standard program that is essential to the analysis and design of complex circuits. In this experiment, you will be introduced to the basics of SPICE. You will learn the basics of representing circuit elements, constructing the circuits, and finally simulating the circuits.

2.0 Material

The version of SPICE you will be using is the student version of PSpice, which is a free product of Cadence. In more advanced courses, you'll be using HSpice, which is the full "industrial strength" version (and definitely not free!) Fortunately, we have a site license to the full Cadence CAD tools for research and education at Berkeley.

3.0 Prelab

- Reading: on-line PSpice manual.
<http://www-inst.eecs.berkeley.edu/~ee105/fa06/PSPICE/PspiceUserGuide.pdf>
- You can download the student version of PSpice from this web site:
<http://www.orcad.com/Product/Simulation/PSpice/eval.asp>
- Supplemental reading: The "Spice Home Page" at <http://bwrc.eecs.berkeley.edu/Classes/IcBook/SPICE/> has an interactive tutorial. The appendix to Experiment 1 is of general use, but some of the information pertains to earlier releases of PSpice.

Procedure

FIGURE P1.

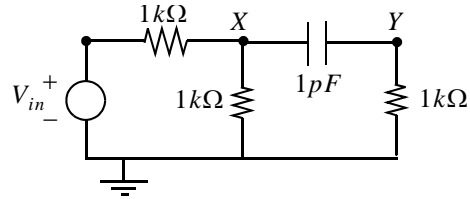

1. Create a netlist for the circuit of Fig. P1. You'll need to name both the elements and the nodes.
2. We would like to have PSpice find the Bode plots for V_x / V_{in} and V_y / V_{in} . Determine how to do this.
3. If you have a PC, run PSpice and generate the magnitude and phase Bode plots. Compare your results with those you find by solving for V_x / V_{in} analytically. Save the file as <your-filename.cir> and bring it on a floppy disk to lab.

4.0 Procedure

4.1 Transient Analysis

1. Solve the Prelab circuit on the PC at your lab station, if you haven't already done it.
2. Construct the PSpice file for the lowpass filter shown below. We are interested in the transient analysis rather than viewing it as a filter. Let the voltage waveform be a 1 kHz square wave that ranges from 0 to 5 V.

FIGURE 2.

Lowpass Filter

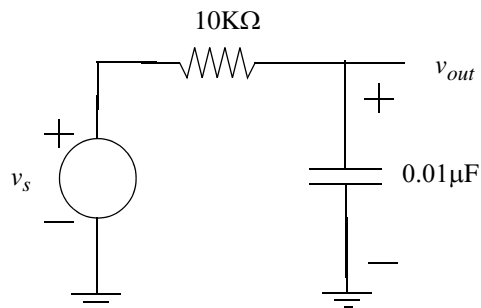

3. Your PSpice file should contain the following information:
 - Circuit information

- .tran statement for the times $t=0$ to $t=10\text{ms}$
- .probe

Lab Tip

The voltage source has the following format:

$Vname$ +node -node dc <dc/tran> transient information

The square wave in the above example can be modeled as either a *pulse* or a *piecewise linear function*. This information goes in your voltage source statements.

4. Launch PSpice by double-clicking on its icon.
5. Click on *File* and *Open*.
6. Select the filename you assigned and PSpice will attempt to analyze the circuit.
7. Click on “File” and “Run Probe.”
8. Probe data files have a .dat extension. It should have been loaded automatically.
9. Click on the *Trace* command followed by *Add*. This will allow you to plot the voltages and currents available in the circuit.

Lab Tip

Probe can also plot mathematical expressions involving the voltages and currents.

You can use the cursor command from the *Tools* menu in probe to get x and y coordinates from the graph.

Labels and Titles can be inserted into your plots for clearer understanding. These are accessible from the *Tools* menu.

10. Print out your plot by clicking on *File* followed by *Print*.
11. From the *Plot* menu, select *Transient*. This will tell probe to plot transient data and not ac data.
12. Obtain a printout for both $v_{out}(t)$ and $v_s(t)$.

4.2 DC Analysis

1. The following circuit contains an n-channel metal-oxide-silicon field effect transistor (n-MOSFET). You *do not* need to know the internal operations of the MOSFET in order to complete this part of the experiment. Enter the circuit below in a SPICE deck.

FIGURE 3.

MOSFET Circuit to Generate its I-V Characteristics

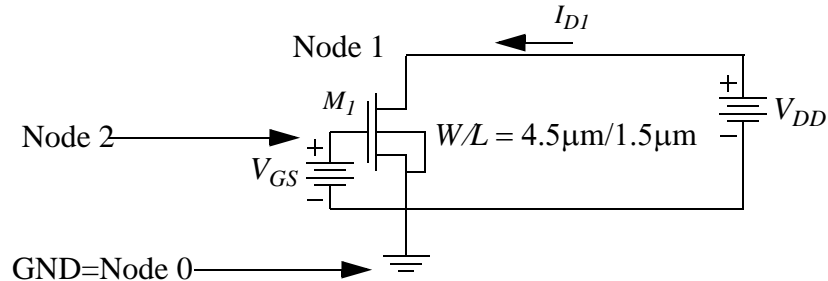

2. Include in your SPICE deck the following:

- `.dc lin VDD 0 5 .1 VGS 0 5 1` (This sweeps V_{DD} from 0 to 5V in .1V interval for each value of V_{GS} . (0 to 5V in 1V intervals))
- `.probe`
- You will need to define the MOSFET's Level 1 PSpice model parameters. Use $K_p=60e-6$, $V_{to}=1$, $\Lambda=0.05$ and the defaults for the rest of the parameters. See pages 239-245 of H&S for information on the Level 1 MOSFET model.

3. Run PSpice and Probe and plot the drain current of your transistor I_{D1} . This will give you the MOSFET's I-V characteristics. Print a hardcopy. Always include your input deck in your lab report.

5.0 Appendix

There are many versions of SPICE available (PSPICE, SPICE3, HSPICE, etc.). Regardless of the version, the structure of an input file is the same. A SPICE simulation consists of 4 parts:

2. Constructing the circuit
3. Specifying the type of analysis
4. Performing the simulation
5. Evaluating the results

5.1 Constructing the Circuit

SPICE can simulate a wide variety of circuit elements. In this tutorial, we will introduce the elements which you will encounter in EE 105.

5.1.1 Two Terminal Elements

Two terminal elements are specified by the + and - terminals. In cases of passive element, such as resistors and capacitors, there is no distinction between the + and - terminals. For voltage sources and current sources, the order of the nodes determines the polarity of the voltage or the direction of the source.

FIGURE 4.

Passive Two Terminal Elements

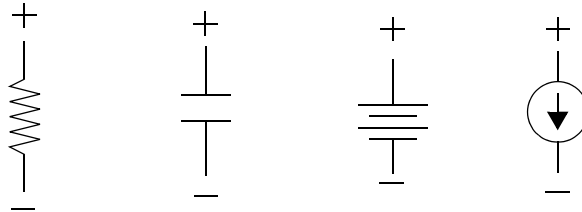

- Resistors (*Rname* <+ node> <- node> value)
- Capacitors (*Cname* <+ node> <- node> value)
- Voltage Source (*Vname* <+ node> <- node> value)
- Current Source (*Iname* <+ node> <- node> value)

5.1.2 Multi-Terminal Elements

FIGURE 5.

Examples of Multiterminal Elements: npn BJT and n-channel MOSFET

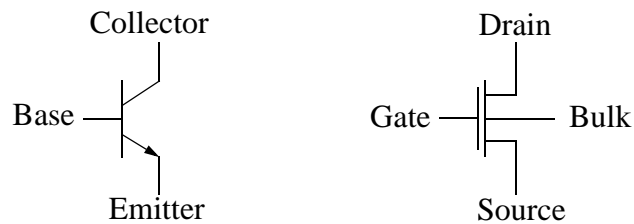

- **Bipolar Transistors** (*Qname* <collector node> <base node> <emitter node> model type)

A bipolar transistor is specified by its collector, base and emitter terminals. The model type tells SPICE to refer to that particular model with its specific parameters.

- **MOSFETS** (*Mname* <drain node> <gate node> <source node> <body node> model type, geometry)

A MOS transistor is specified by its drain, gate, source and body terminals along with the name of a model. If the geometry is not specified, it will have a gate length and

width of $1\mu\text{m}$. It is important to note that on a circuit, the body is often not labeled as a “terminal”. Most often, for a NMOS, the body is either tied to ground or to the source and for the PMOS, the body is either tied to the power supply or the source.

Note that whenever you are modeling an active device, you must specify it with a .model statement in SPICE. For example, if you want to model an npn BJT with the following properties: β of 100, V_A of 100V, and $I_S = 1 \times 10^{-15}\text{A}$.

You would include the following statement:

```
.model n1 npn Bf=100 Vaf=100 Is=1e-15
```

Consult the PSPICE manual for the form of .model lines for other active devices.

5.2 Entering the SPICE Deck

You will be using PSpice for Windows in room 123. In order to enter the SPICE deck, you will need to use a text editor. The editor you should use is **Notepad** found in the **Accessories** group.

Once you have finished entering your SPICE deck, save the file. The filename should be in the format *<your filename>.cir*. The filename should be no more than 8 characters long, not including the .cir extension.

Your SPICE deck should have the following format:

- The first line must be a title.
- The end of the deck is defined with a **.end** statement.
- It is often a good practice to group the netlist with the following format:
 1. Title
 2. Circuit Elements
 3. .model statements
 4. analysis and options statements
 5. .end
- note: Any statement that is preceded by “*” is recognized as a comment. It is often a good idea to comment your netlist so that others can understand what you’re doing.
- Nodes can be represented as numbers as well as strings. Use meaningful nodenames. Ground is *always* node 0.

5.3 Running PSPICE

The file you have created in **Notebook** is ready to be simulated. You can open the PSPICE windows by double-clicking the PSPICE A_D icon. A window which resembles figure 5 will appear.

To simulate your SPICE deck,

1. Click on *File* then *Open*.

2. Select the SPICE deck you want to simulate.

FIGURE 6.

The PSpice Window

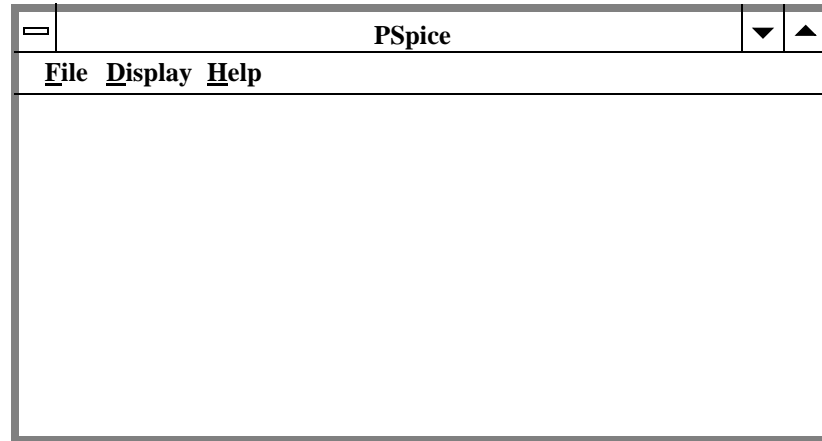

Lab Tip

Note the path in which you have saved your SPICE deck. If you don't see your **Notebook** file, select *All Files* in the filter within the dialog box. If the file is still not there, then PSPICE is not looking in the directory in which you saved your .cir file. You will have to traverse up or down the directory tree until you reach the correct directory.

If the circuit contains no error, PSPICE will display a message telling you that the simulation was successful. If there were errors, then you will need to fix it within your SPICE deck. You can view your errors by clicking *File* and then *Examine Output*.

5.4 Running Probe

Probe is a graphing program which plots data obtained from a PSPICE simulation. You can launch Probe by clicking "File" and then "Run Probe." A window which resembles figure 6 will appear.

In order to run probe, you must include the following line in your SPICE deck:

```
.probe
```

Data for Probe is stored with the same name as your SPICE deck file, with the .dat extension. For example, if your SPICE deck was named *test.cir*, the data file for Probe will be named *test.dat*.

FIGURE 7.

The Probe Window

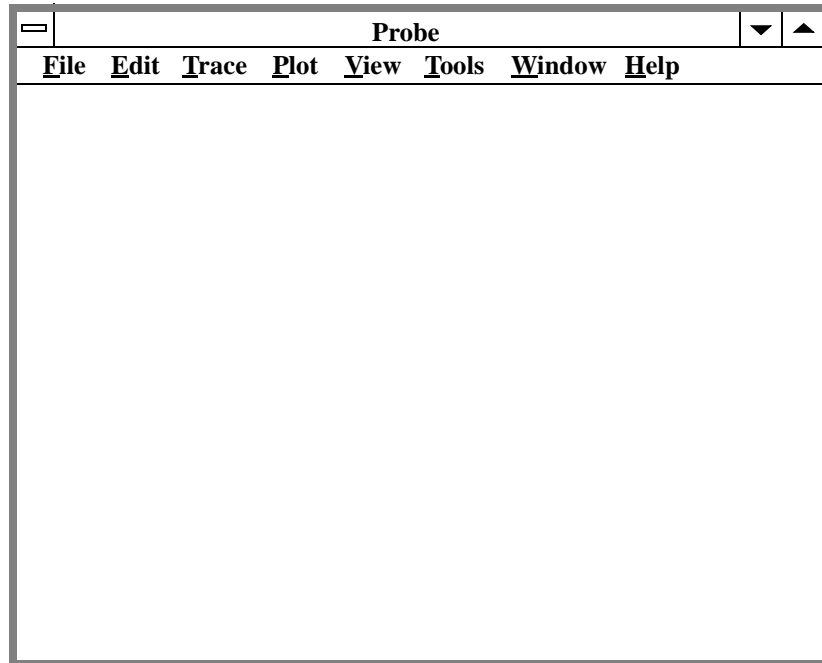

You can also run probe in the “Accessories” directory. If you do this, then before plotting your data, you must open the .dat file. This can be done in the *File* menu.

If your simulation contains multiple types of analysis (dc, ac or transient) you can specify which type of data to load into probe in the *plot* menu.

Data is plotted using the *Add* function in the *Trace* Menu.

You can obtain a hardcopy of the plot by using the *Print* function in the *File* Menu.

Lab Tip

Label your plots with insightful comments. Somewhere on your plot you should include your name. This can make identifying your plot an easier job.

If the print queue is long, you can convert the plot in *postscript* format. Use the *Printer Select* function in the *File* Menu.
