

## Lecture #40

**Today:** A little side excursion into nitty-gritty stuff: Storage management

## Scope and Lifetime

- *Scope* of a declaration is portion of program text to which it applies (*is visible*).
  - Need not be contiguous.
  - In Java, is static: independent of data.
- *Lifetime* or *extent* of storage is portion of program execution during which it exists.
  - Always contiguous
  - Generally dynamic: depends on data
- *Classes of extent*:
  - *Static*: entire duration of program
  - *Local* or *automatic*: duration of call or block execution (local variable)
  - *Dynamic*: From time of allocation statement (**new**) to deallocation, if any.

## Explicit vs. Automatic Freeing

- Java has no means to free dynamic storage.
- However, when no expression in any thread can possibly be influenced by or change an object, it might as well not exist:

```
IntList wasteful ()
{
    IntList c = new IntList (3, new IntList (4, null));
    return c.tail;
    // variable c now deallocated, so no way
    // to get to first cell of list
}
```

- At this point, Java runtime, like Scheme's, recycles the object *c* pointed to: *garbage collection*.

## Under the Hood: Allocation

- Java pointers (references) are represented as integer addresses.
- Corresponds to machine's own practice.
- In Java, cannot convert integers ↔ pointers,
- But crucial parts of Java runtime implemented in *C*, or sometimes machine code, where you can.
- Crude allocator in *C*:

```
char store[STORAGE_SIZE]; // Allocated array
size_t remainder = STORAGE_SIZE;

/** A pointer to a block of at least N bytes of storage */
void* simpleAlloc (size_t n) { // void*: pointer to anything
    if (n > remainder) ERROR ();
    remainder = (remainder - n) & ~0x7; // Make multiple of 8
    return (void*) (store + remainder);
}
```

## Example of Storage Layout: Unix

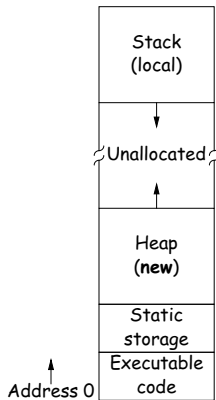

- OS gives way to turn chunks of unallocated region into heap.
- Happens automatically for stack.

## Explicit Deallocating

- C/C++ normally require explicit deallocation, because of
  - Lack of run-time information about what is array
  - Possibility of converting pointers to integers.
  - Lack of run-time information about *unions*:
 

```
union Various {
    int Int;
    char* Pntr;
    double Double;
} X; // X is either an int, char*, or double
```
- Java avoids all three problems; automatic collection possible.
- Explicit freeing can be somewhat faster, but rather error-prone:
  - Memory corruption
  - Memory leaks

## Free Lists

- Explicit allocator grabs chunks of storage from OS and gives to applications.
- Or gives recycled storage, when available.
- When storage is freed, added to *free list* data structure to be recycled.
- Used both for explicit freeing and some kinds of automatic garbage collection.
- Problem: *free memory fragments*.

## Boundary Tag Methods

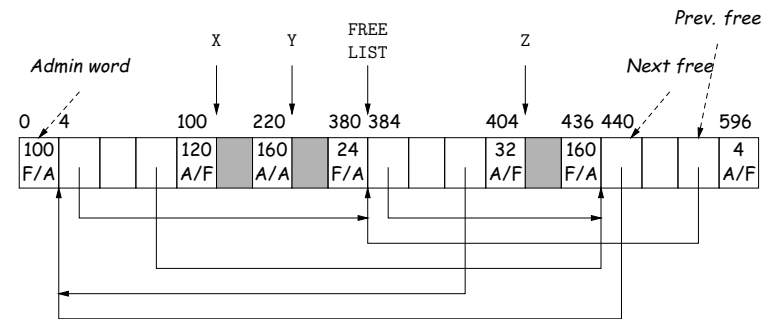

```
G1 = malloc(96);
X = malloc(115);
Y = malloc(156);
G2 = malloc(19);
Z = malloc(26);
G3 = malloc(155);
free(G1); free(G3); free(G2);
```

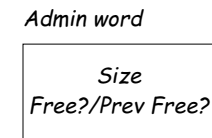

## Simplifying Coalescence: The Buddy System

- Allocate in powers of 2.
- Coalesce only with your buddy:
  - For object of size  $2^n$  at byte # $M$ , buddy at byte # $(M \oplus (1 \ll n))$ .
  - Just need a bit to indicate if it is allocated, plus list of free blocks for each  $n$ .

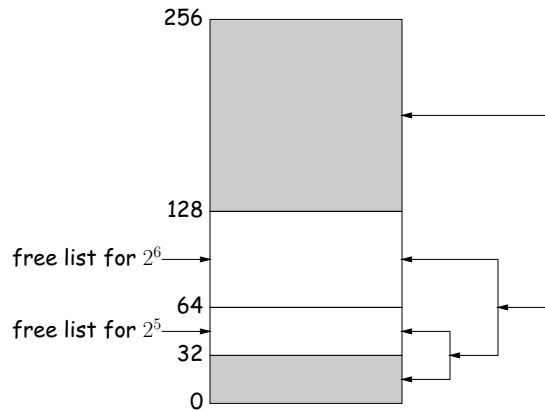

Last modified: Fri Apr 28 14:47:37 2006

CS61B: Lecture #40 9

## Buddy System at Work

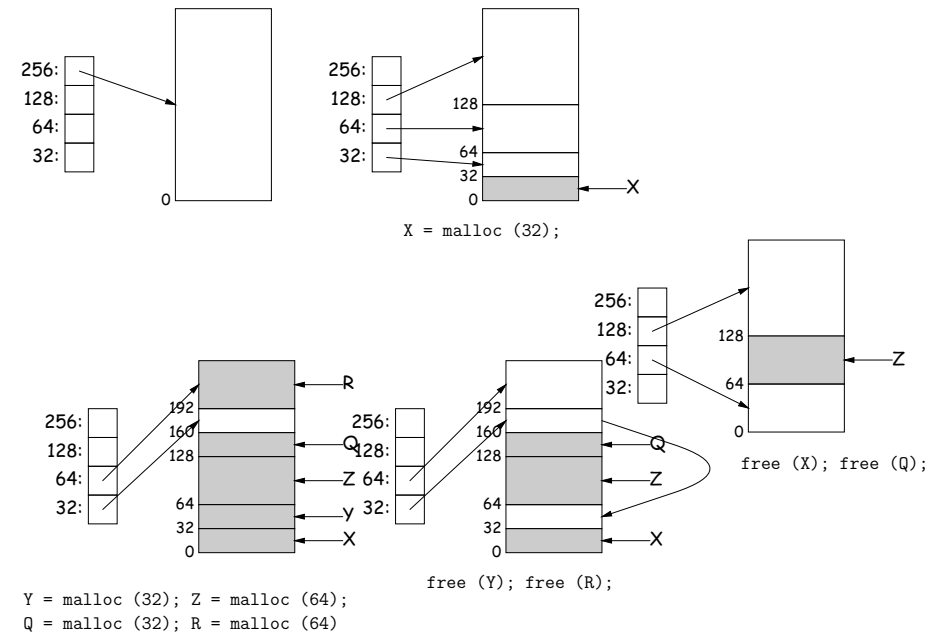

Last modified: Fri Apr 28 14:47:37 2006

CS61B: Lecture #40 10

## Garbage Collection: Reference Counting

- Idea: Keep count of number of pointers to each object. Release when count goes to 0.

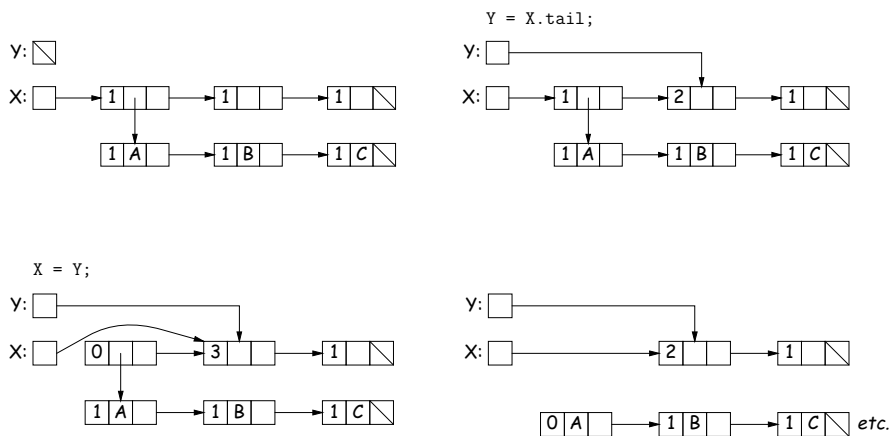

Last modified: Fri Apr 28 14:47:37 2006

CS61B: Lecture #40 11

## Garbage Collection: Mark and Sweep

Roots (locals + statics)

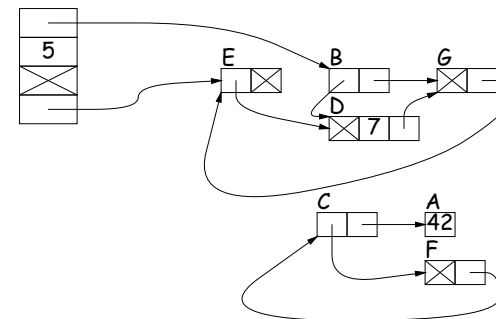

1. Traverse and **mark** graph of objects.
2. **Sweep** through memory, freeing unmarked objects.

Before sweep: A 42 B\* D G C F A D\* 7 G E\* D F C G\* E

After sweep: B D G D 7 G E G E

Last modified: Fri Apr 28 14:47:37 2006

CS61B: Lecture #40 12

## Copying Garbage Collection

- Mark-and-sweep algorithms don't move any existing objects—pointers stay the same.
- The total amount of work depends on the amount of memory swept—i.e., the total amount of active (non-garbage) storage + amount of garbage. Not necessarily a big hit: the garbage had to be active at one time, and hence there was always some "good" processing in the past for each byte of garbage scanned.
- Another approach: *copying garbage collection* takes time proportional to amount of active storage:
  - Traverse the graph of active objects breadth first, *copying* them into a large contiguous area (called "to-space").
  - As you copy each object, mark it and put a *forwarding pointer* into it that points to where you copied it.
  - The next time you have to copy a marked object, just use its forwarding pointer instead.
  - When done, the space you copied from ("from-space") becomes the next to-space; in effect, all its objects are freed in constant time.

## Copying Garbage Collection Illustrated

