

CS61B Lecture #33

Today's Readings: Graph Structures: *DSIJ*, Chapter 12

Why Graphs?

- For expressing non-hierarchically related items
- Examples:
 - Networks: pipelines, roads, assignment problems
 - Representing processes: flow charts, Markov models
 - Representing partial orderings: PERT charts, makefiles

Some Terminology

- A *graph* consists of
 - A set of *nodes* (aka *vertices*)
 - A set of *edges*: pairs of nodes.
 - Nodes with an edge between are *adjacent*.
 - Depending on problem, nodes or edges may have *labels* (or *weights*)
- Typically call node set $V = \{v_0, \dots\}$, and edge set E .
- If the edges have an order (first, second), they are *directed edges*, and we have a *directed graph (digraph)*, otherwise an *undirected graph*.
- Edges are *incident* to their nodes.
- Directed edges *exit* one node and *enter* the next.
- A *cycle* is a path without repeated edges leading from a node back to itself (following arrows if directed).
- A graph is *cyclic* if it has a cycle, else *acyclic*. Abbreviation: Directed Acyclic Graph—*DAG*.

Some Pictures

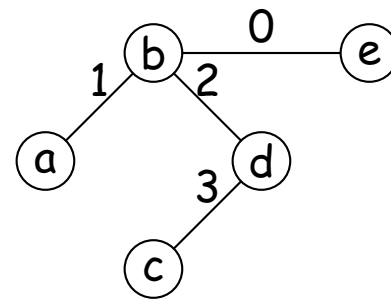
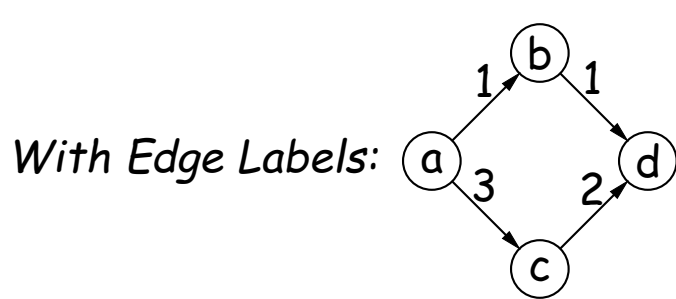
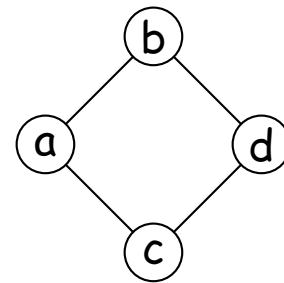
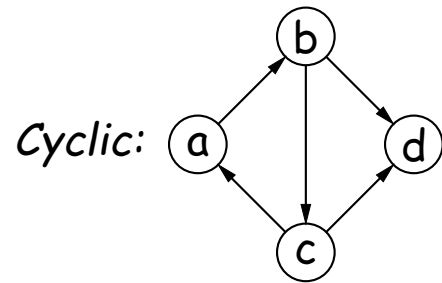
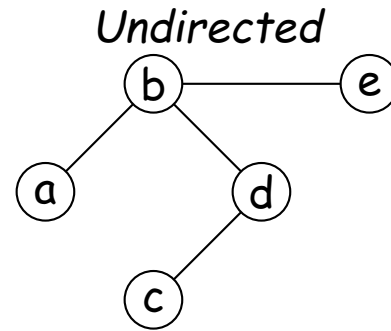
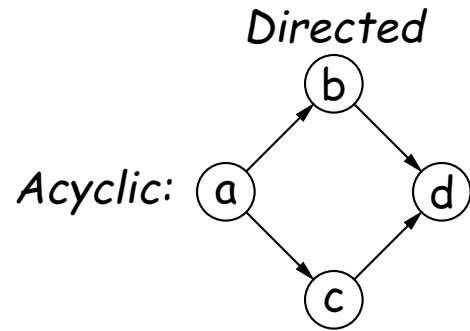

Trees are Graphs

- A graph is *connected* if there is a (possibly directed) path between every pair of nodes.
- That is, if one node of the pair is *reachable* from the other.
- A DAG is a (rooted) tree iff connected, and every node but the root has exactly one parent.
- A connected, acyclic, undirected graph is also called a *free tree*. Free: we're free to pick the root; e.g.,

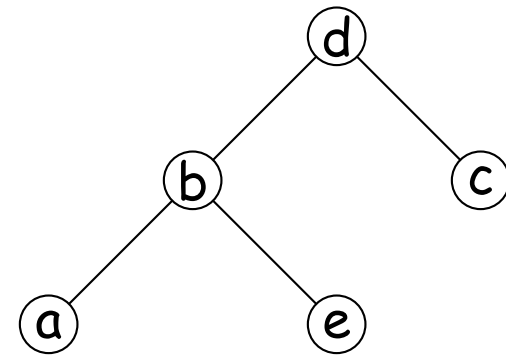
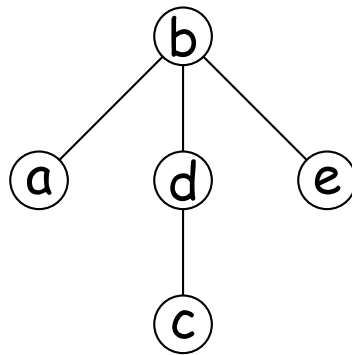
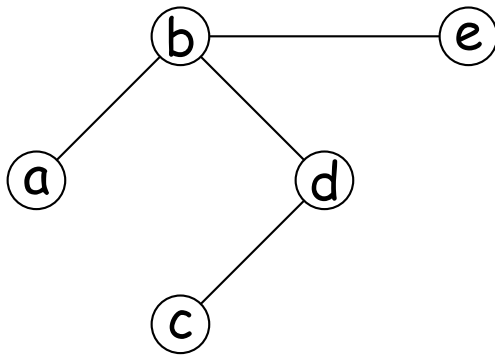

Examples of Use

- Edge = Connecting road, with length.

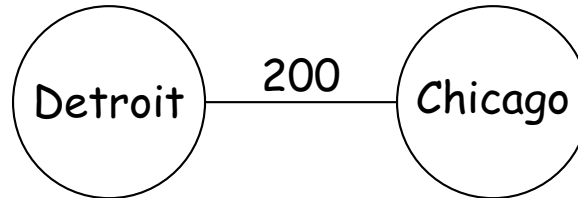

- Edge = Must be completed before; Node label = time to complete.

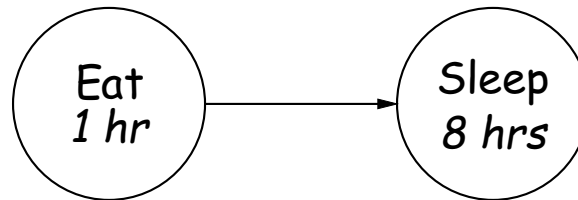

- Edge = Begat

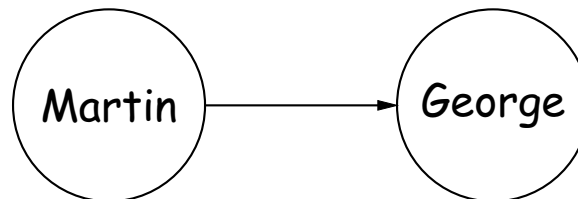

More Examples

- Edge = some relationship

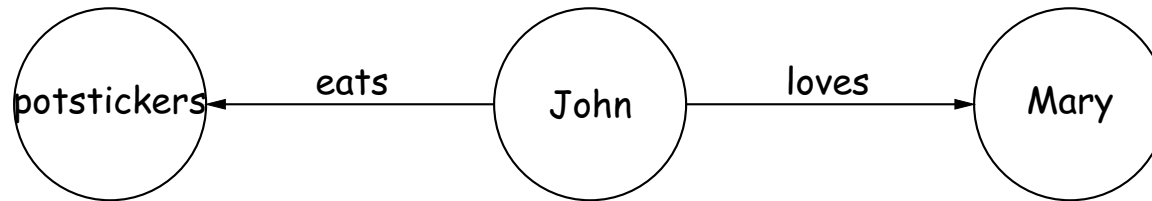

- Edge = next state might be (with probability)

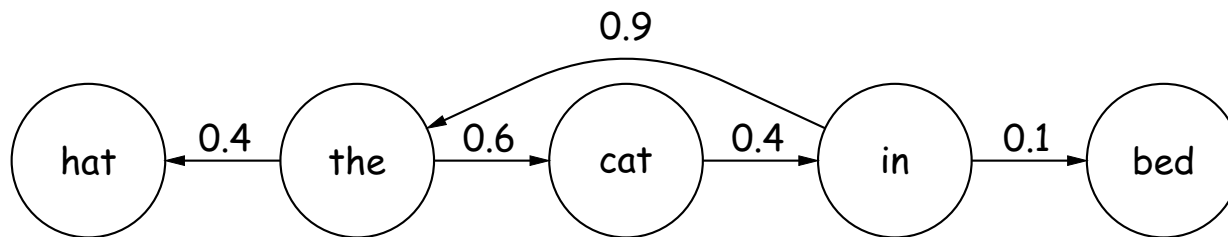

- Edge = next state in state machine, label is triggering input. (Start at s. Being in state 4 means "there is a substring '001' somewhere in the input".)

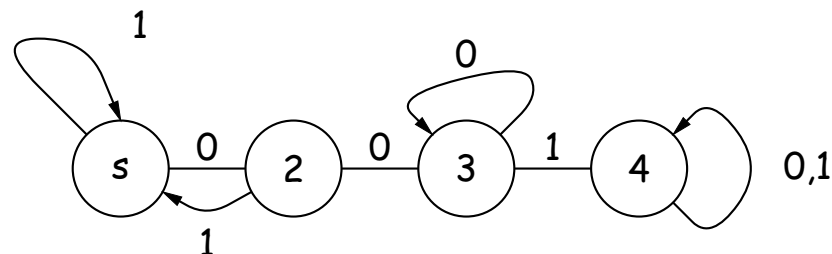

Representation

- Often useful to number the nodes, and use the numbers in edges.
- *Edge list representation*: each node contains some kind of list (e.g., linked list or array) of its successors (and possibly predecessors).

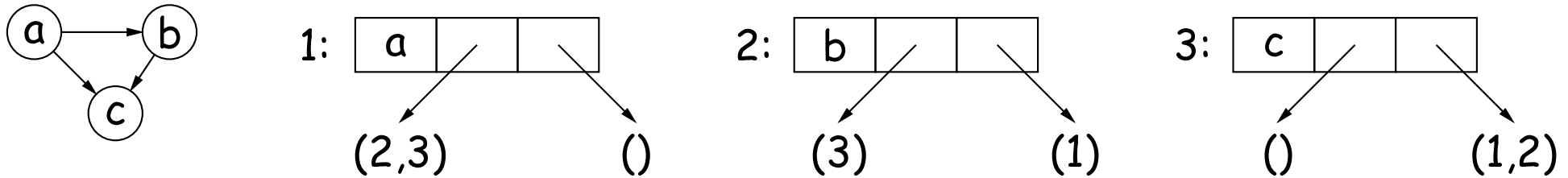

- *Edge sets*: Collection of all edges. For graph above:

$$\{(1, 2), (1, 3), (2, 3)\}$$

- *Adjacency matrix*: Represent connection with matrix entry:

$$\begin{array}{c} 1 \quad 2 \quad 3 \\ 1 \quad \begin{bmatrix} 0 & 1 & 1 \end{bmatrix} \\ 2 \quad \begin{bmatrix} 0 & 0 & 1 \end{bmatrix} \\ 3 \quad \begin{bmatrix} 0 & 0 & 0 \end{bmatrix} \end{array}$$

Traversing a Graph

- Many algorithms on graphs depend on traversing all or some nodes.
- Can't quite use recursion because of cycles.
- Even in acyclic graphs, can get combinatorial explosions:

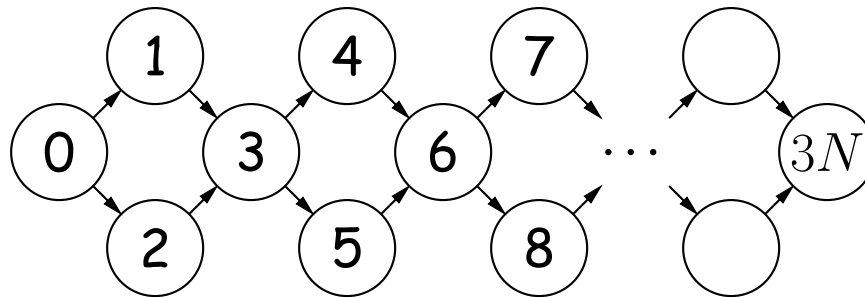

Treat 0 as the root and do recursive traversal down the two edges out of each node: $\Theta(2^N)$ operations!

- So typically try to visit each node constant # of times (e.g., once).

Recursive Depth-First Traversal of a Graph

- Can fix looping and combinatorial problems using the “bread-crumbs” method used in earlier lectures for a maze.
- That is, *mark* nodes as we traverse them and don't traverse previously marked nodes.
- Makes sense to talk about *preorder* and *postorder*, as for trees.

```
void preorderTraverse(Graph G, Node v)
{
    if (v is unmarked) {
        mark(v);
        visit v;
        for (Edge(v, w) ∈ G)
            traverse(G, w);
    }
}
```

```
void postorderTraverse(Graph G, Node v)
{
    if (v is unmarked) {
        mark(v);
        for (Edge(v, w) ∈ G)
            traverse(G, w);
        visit v;
    }
}
```

Recursive Depth-First Traversal of a Graph (II)

- We are often interested in traversing *all* nodes of a graph, not just those reachable from one node.
- So we can repeat the procedure as long as there are unmarked nodes.

```
void preorderTraverse(Graph G) {  
    for (v ∈ nodes of G) {  
        preorderTraverse(G, v);  
    }  
}
```

```
void postorderTraverse(Graph G) {  
    for (v ∈ nodes of G) {  
        postorderTraverse(G, v);  
    }  
}
```

Topological Sorting

Problem: Given a DAG, find a linear order of nodes consistent with the edges.

- That is, order the nodes v_0, v_1, \dots such that v_k is never reachable from $v_{k'}$ if $k' > k$.
- Gmake does this. Also PERT charts.

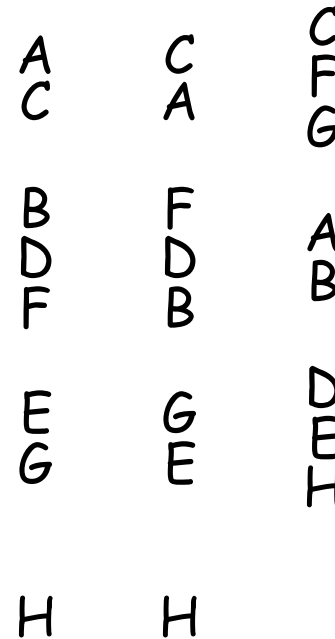
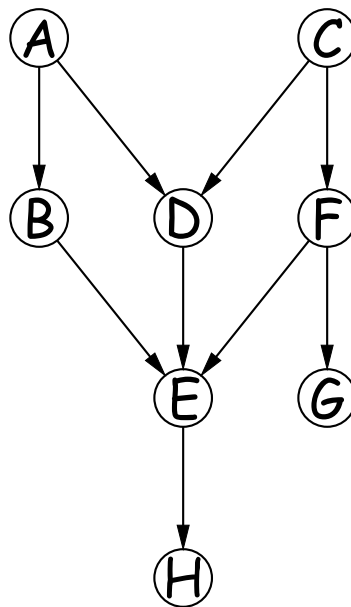
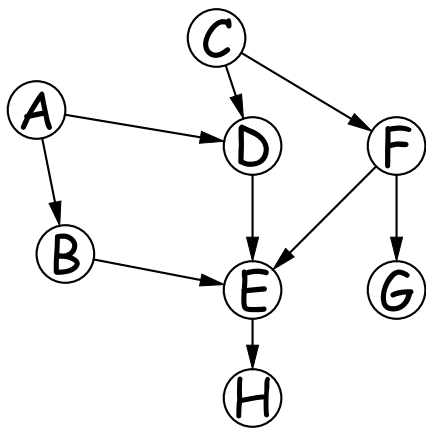

Sorting and Depth First Search

- **Observation:** Suppose we *reverse the links* on our graph.
- If we do a recursive DFS on the reverse graph, starting from node H, for example, we will find all nodes that must come *before* H.
- When the search reaches a node in the reversed graph and there are no successors, we know that it is safe to put that node first.
- In general, a *postorder* traversal of the reversed graph visits nodes only after all predecessors have been visited.

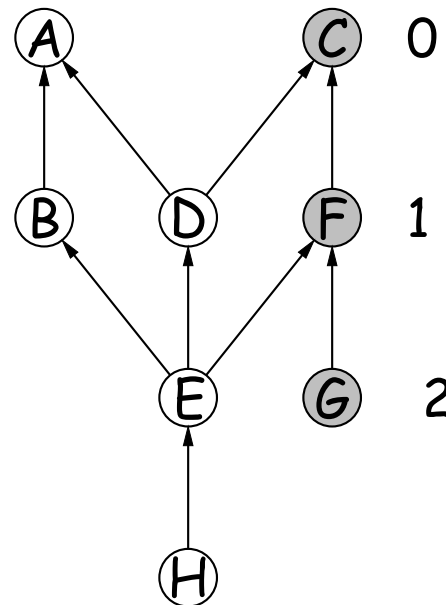
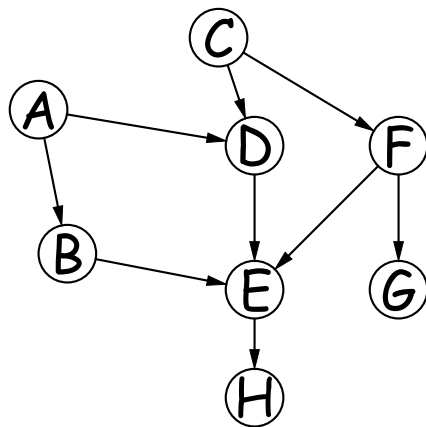

Numbers show post-order traversal order starting from G: everything that must come before G.

General Graph Traversal Algorithm

```
COLLECTION_OF_VERTICES fringe;
```

```
fringe = INITIAL_COLLECTION;
```

```
while (!fringe.isEmpty()) {
```

```
    Vertex v = fringe.REMOVE_HIGHEST_PRIORITY_ITEM();
```

```
    if (!MARKED(v)) {
```

```
        MARK(v);
```

```
        VISIT(v);
```

```
        For each edge(v,w) {
```

```
            if (NEEDS_PROCESSING(w))
```

```
                Add w to fringe;
```

```
        }
```

```
    }
```

```
}
```

Replace *COLLECTION_OF_VERTICES*, *INITIAL_COLLECTION*, etc. with various types, expressions, or methods to different graph algorithms.

Example: Depth-First Traversal

Problem: Visit every node reachable from v once, visiting nodes further from start first.

```
Stack<Vertex> fringe;

fringe = stack containing {v};
while (!fringe.isEmpty()) {
    Vertex v = fringe.pop();

    if (!marked(v)) {
        mark(v);
        VISIT(v);
        For each edge(v,w) {
            if (!marked(w))
                fringe.push(w);
        }
    }
}
```

Depth-First Traversal Illustrated

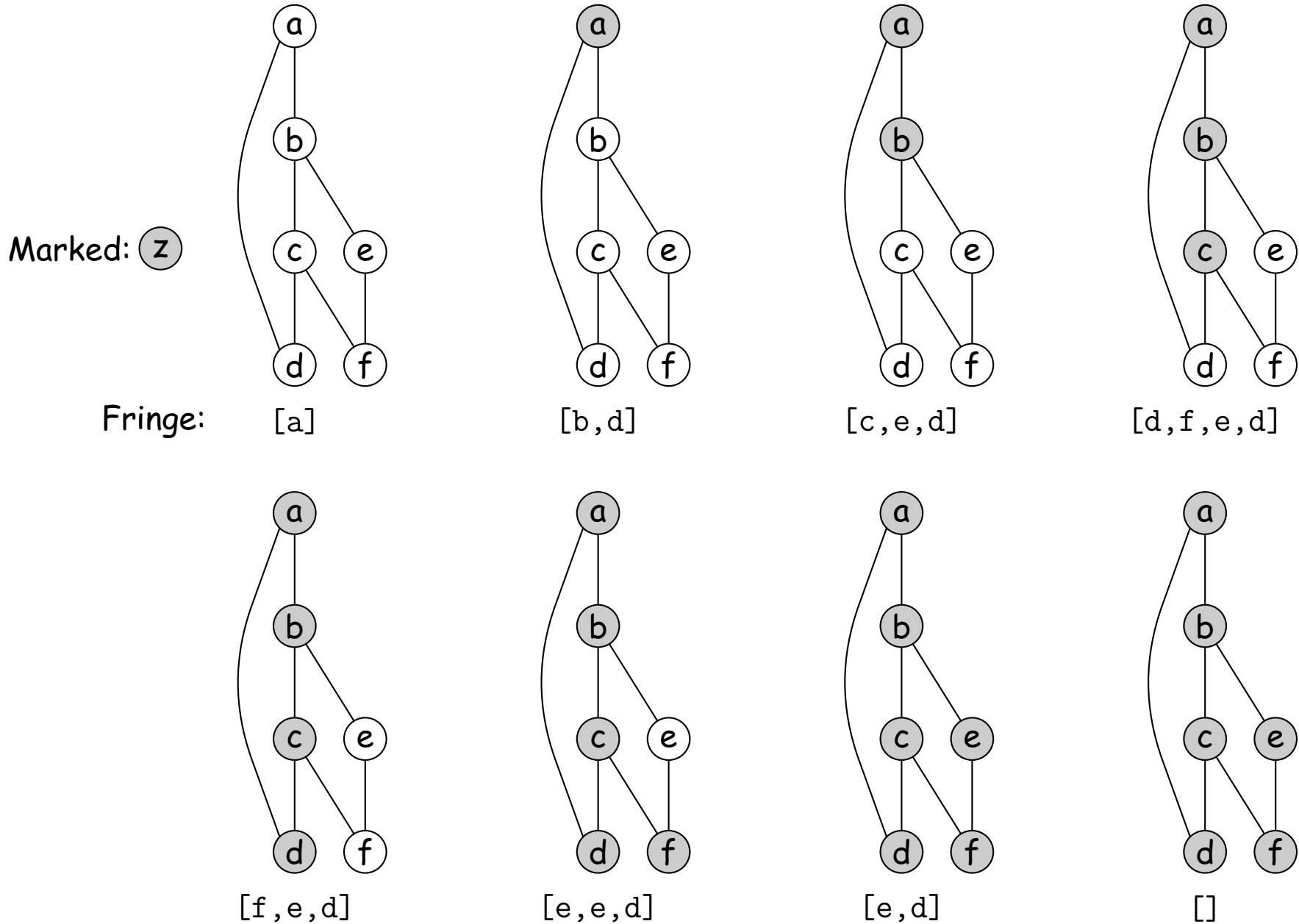

Topological Sort in Action

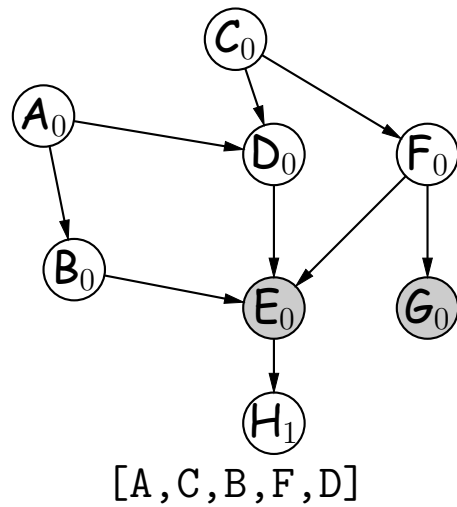
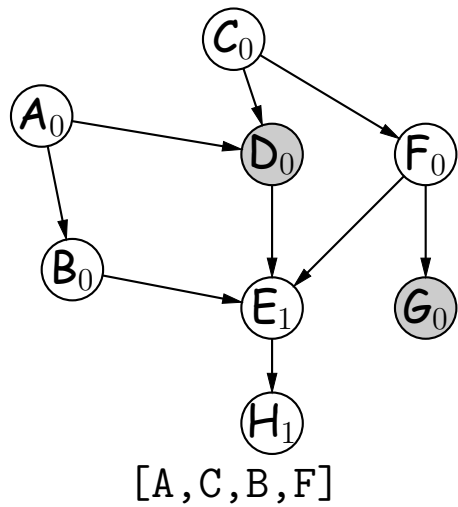
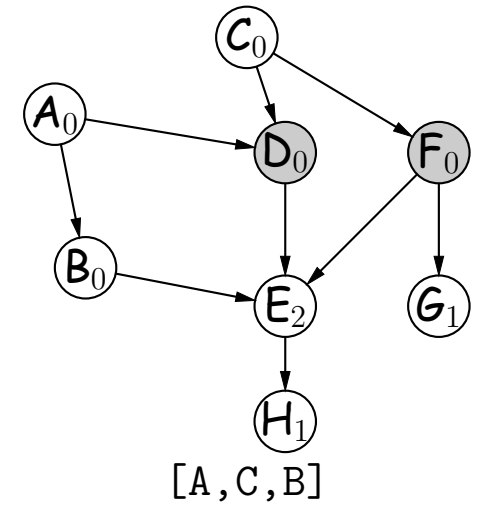
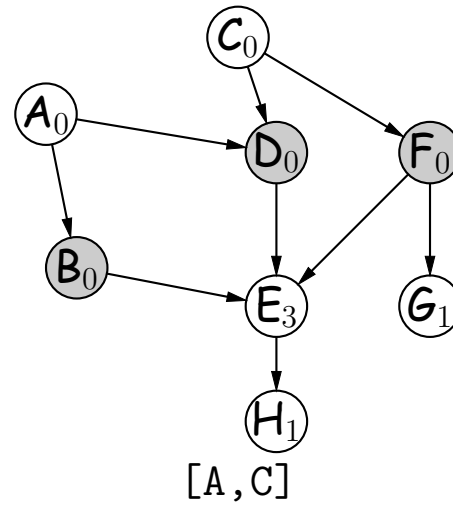
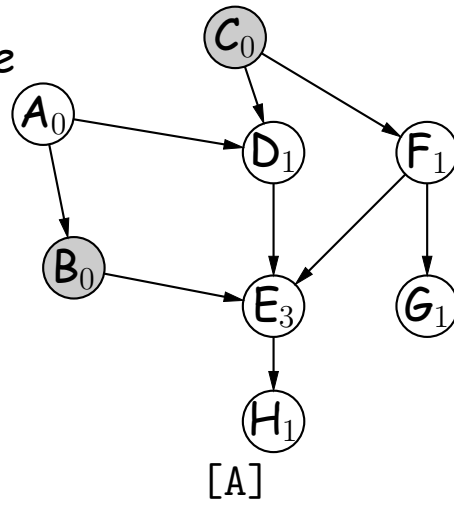
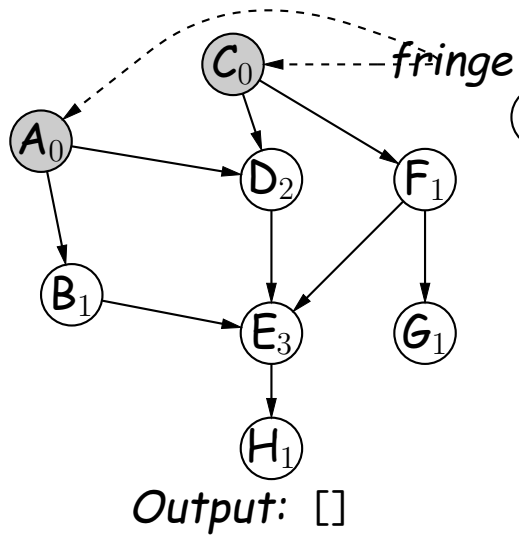

...

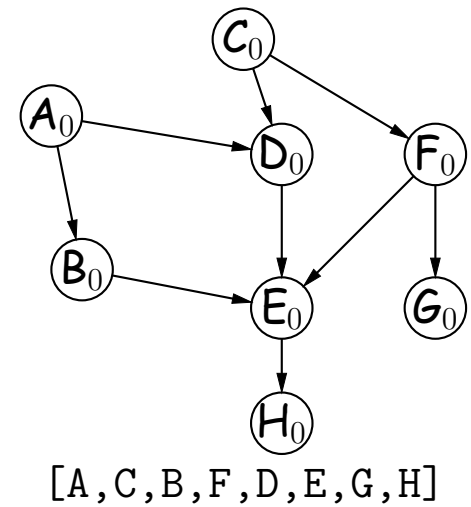

Shortest Paths: Dijkstra's Algorithm

Problem: Given a graph (directed or undirected) with non-negative edge weights, compute shortest paths from given source node, s , to all nodes.

- "Shortest" = sum of weights along path is smallest.
- For each node, keep estimated distance from s , ...
- ...and of preceding node in shortest path from s .

```
PriorityQueue<Vertex> fringe;
For each node v { v.dist() =  $\infty$ ; v.back() = null; }
s.dist() = 0;
fringe = priority queue ordered by smallest .dist();
add all vertices to fringe;
while (!fringe.isEmpty()) {
    Vertex v = fringe.removeFirst();

    For each edge(v,w) {
        if (v.dist() + weight(v,w) < w.dist())
            { w.dist() = v.dist() + weight(v,w); w.back() = v; }
    }
}
```

Example

